

ibaM-4AI-600V-AC

Input module for analog signals

Manual

Issue 1.3

Measurement Systems for Industry and Energy

www.iba-ag.com

Manufacturer

iba AG
Gebhardtstrasse 10-20
90762 Fuerth
Germany

Contacts

Headquarters +49 911 97282-0
Support +49 911 97282-14
Engineering +49 911 97282-13
Email iba@iba-ag.com
Web www.iba-ag.com

This manual must not be circulated or copied, or its contents utilized and disseminated, without our express written permission. Any breach or infringement of this provision will result in liability for damages.

©iba AG 2026, All rights reserved

The content of this publication has been checked for compliance with the described hardware and software. Nevertheless, deviations cannot be excluded completely so that the full compliance is not guaranteed. However, the information in this publication is updated regularly. Required corrections are contained in the following regulations or can be downloaded on the Internet.

The current version is available for download on our website www.iba-ag.com and can be found in the iba Help center docs.iba-ag.com.

Issue	Date	Revision	Author	Version HW/FW
1.3	03-2026	Circuit diagram, power frequency	st	1.02.004

Windows® is a label and registered trademark of the Microsoft Corporation. Other product and company names mentioned in this manual can be labels or registered trademarks of the corresponding owners.

Certification

The product is certified according to the European standards and directives. This product meets the general safety and health requirements.

Other international and national standards were observed.

Contents

1	About this documentation	5
1.1	Target group.....	5
1.2	Notations	5
1.3	Used symbols.....	6
2	About ibaM-4AI-600V-AC	7
3	Scope of delivery.....	8
4	Safety and other instructions	9
4.1	Intended use.....	9
4.2	Special safety instructions	10
5	System requirements	13
6	Mounting and dismantling	14
6.1	Disconnection from the grid.....	15
6.2	Modules.....	16
6.3	End cover	17
6.4	Connection technology connector	18
7	Device description.....	19
7.1	View.....	19
7.2	Indicating elements	19
7.2.1	Module status.....	19
7.2.2	Analog input status.....	20
7.3	Analog inputs.....	20
7.3.1	Filters	20
7.3.2	Power frequency measurement	21
7.3.3	Connection diagram, pin assignment	21
7.4	Type label.....	23
8	Configuration in ibaPDA	24
8.1	Adding modules.....	24
8.1.1	Adding module automatically.....	24
8.1.2	Adding module manually / offline	25
8.2	Module configuration	26

8.2.1	ibaM-4AI-600V-AC – General tab.....	26
8.2.2	ibaM-4AI-600V-AC – Analog tab.....	28
8.2.3	ibaM-4AI-600V-AC – Power frequency tab.....	29
8.2.4	ibaM-4AI-600V-AC – Diagnostics tab.....	30
9	Technical data	31
9.1	Main data.....	31
9.2	Analog inputs.....	32
9.3	Declaration of conformity.....	34
9.4	Dimensions	34
10	Accessories	35
11	Support and contact.....	36

1 About this documentation

This documentation describes the design, application and operation of the device *ibaM-4AI-600V-AC*.

Note



Observe this danger sign:



In all cases where this danger sign is displayed, refer to the manual to find out more about the nature of the potential hazards and the measures that must be taken to avoid them.

1.1 Target group

This documentation is aimed at qualified professionals who are familiar with handling electrical and electronic modules as well as communication and measurement technology. A person is regarded as professional if they are capable of assessing safety and recognizing possible consequences and risks on the basis of their specialist training, knowledge and experience and knowledge of the standard regulations.

1.2 Notations

In this manual, the following notations are used:

Action	Notation
Menu command	Menu <i>Logic diagram</i>
Calling the menu command	<i>Step 1 – Step 2 – Step 3 – Step x</i> Example: Select the menu <i>Logic diagram – Add – New function block</i> .
Keys	<Key name> Example: <Alt>; <F1>
Press the keys simultaneously	<Key name> + <Key name> Example: <Alt> + <Ctrl>
Buttons	<Key name> Example: <OK>; <Cancel>
Filenames, paths	Filename, Path Example: Test.docx

1.3 Used symbols

If safety instructions or other notes are used in this manual, they mean:

Danger!



The non-observance of this safety information may result in an imminent risk of death or severe injury!

Observe the specified measures.

Warning!



The non-observance of this safety information may result in a potential risk of death or severe injury!

Observe the specified measures.

Caution!



The non-observance of this safety information may result in a potential risk of injury or material damage!

Observe the specified measures.

Note



A note specifies special requirements or actions to be observed.

Tip



Tip or example as a helpful note or insider tip to make the work a little bit easier.

Other documentation



Reference to additional documentation or further reading.

2 About ibaM-4AI-600V-AC

Modular concept

The I/O module described in this documentation is part of the ibaMAQS modular measurement system.

The modular system consists of a central unit (*ibaM-DAQ* processor module or the *ibaM-COM* communication module), which can be combined with up to 15 different I/O modules. Modules are available for discrete input and output signals as well as for special technological features.

The I/O modules do not require their own power supply since they are powered via the module-module interface. The operating status of the module as well as the status of the individual channels are indicated by LEDs.

ibaM-4AI-600V-AC

The *ibaM-4AI-600V-AC* module is designed for power monitoring applications and can sample at 500 kHz. The module provides 2 measuring ranges per channel.

Overview of the most important features:

- Input module with 4 analog voltage inputs
- For nominal voltages of 600 V AC
- Use in power generation and distribution
- General voltage measurement
- Power frequency measurement
- Galvanically isolated analog inputs
- 24 bit resolution
- Sampling rate A/D converter 500 kHz
- Timebase min. 2 μ s, freely adjustable
- Analog and digital filters per channel
- Measuring ranges ± 360 V; ± 1700 V, switchable
- Protection class (IEC 61010): CAT III 600 V; CAT IV 300 V; pollution degree 2
- Rugged housing, easy installation

3 Scope of delivery

After unpacking, check that the delivery is complete and undamaged.

The scope of delivery includes:

- *ibaM-4AI-600V-AC* device
- 2x 4-pin connector with spring terminals

4 Safety and other instructions

Note



Work on the system, as well as mounting and dismounting, must only be carried out by trained and qualified specialists.

Careful working methods and compliance with safety measures when working with electrical devices of all types must be observed.

Note



Observe this danger sign:



In all cases where this danger sign is displayed, refer to the manual to find out more about the nature of the potential hazards and the measures that must be taken to avoid them.

4.1 Intended use

The device is an electrical equipment. It must only be used for the following applications:

- Measurement data acquisition and analysis
- Applications of software products (*ibaPDA*, *ibaLogic* etc.) and hardware products from iba AG.

The device must only be used as specified in the *Technical data* chapter, and is designed and approved for continuous operation.

Danger!



Electric shock

The device is only designed for electrical measured variables as specified in the “Technical data” chapter!

If the device is used or operated in a manner other than specified in the *Technical data* chapter, the protection supported by the device may be impaired.

This applies in particular to the permissible operating and environmental conditions and voltages outside the corresponding CAT protection classes.

4.2 Special safety instructions

Danger!



Operation

- The system must only be operated permanently connected and not touchable, only in a building (in-door) and only in a fire protection housing in accordance with IEC 61010-1.
 - The system must only be operated with a mounted end cover.
 - The external power supply/power supply unit for supplying the central unit and thus for the complete system must be tested for use with this system in accordance with IEC 61010-1.
 - Modules from this system must only be operated with a central processing unit from this system.
 - The supply voltage for this system must only be fed from this system via a central unit.
 - The supply may only be provided via an energy-limited circuit in accordance with IEC 61010-1 and must either include a fuse that trips after 120 s at the latest in the event of an overcurrent greater than 4 A or limit the total current of the system to 4 A.
 - In addition to their own current consumption from the supply voltage via the module-module interface, the central units and the modules also pass on the supply voltage for other connected modules, so that the module-module interfaces may have to carry the maximum specified total current of the system.
 - Only a maximum of 15 modules may be installed next to the central unit.
-

Danger!



Duty of care

Take care when working on the system and always check that the system and the modules themselves are in perfect condition, as well as ensuring that they are properly installed and correctly attached to the DIN rail.

If damage to cables, devices, supplies or enclosures is detected before commissioning or during operation, the system must not be put into operation or must be taken out of operation immediately.

Warning!**Mounting and dismounting / Disconnection from the grid**

Work on the device or system may only be carried out when the power is switched off!

Due to the modular concept of this system, modules connected in series with this module can also carry dangerous voltages.

All energized components of all modules in the system must therefore be disconnected from the grid before mounting and dismounting.

In addition to disconnecting the power supply at the system's central unit, the signal plugs and connections of all modules in the system must also be de-energized or disconnected from the grid.

Caution!

A suitable disconnecting device for this system must be available and disconnect all energized components of this system.

This disconnecting device must include a switch or circuit breaker that is easily accessible at a suitable location in the vicinity and is also clearly marked as a disconnecting device for this system.

Caution!**Measuring cable**

- Do not use damaged measuring cables!
 - Do not connect or disconnect measuring cables when the device is connected to the power!
 - Measuring cables must be suitable for the measurement category and voltage, and must have a length of smaller than 10 m.
-

Caution!

You must only connect one conductor to each terminal connection.

Several individual conductors, whether single-wired or fine-wired, are not permitted.

Only connectors classified by iba may be used for connecting conductors.

Caution!

If the display of an analog input lights up red, the input signal is outside the displayable and permissible range.



The actual voltage at the input is higher than the permitted voltage.

Note

Do not open the device! Opening the device results in a loss of warranty!

Note

The device does not require any special cleaning or maintenance!

However, if you want to carry out an inspection or recalibration, return the device to iba.

Note**Calibration**

If the device is used or operated in the manner specified in the *Technical data* chapter, a calibration interval of 4 years is recommended for the analog input channels.

The date of the last calibration can be found in *ibaPDA* and there in the system information on the *Info* tab of the central processing unit.

5 System requirements

Hardware

ibaMAQS central unit

- *ibaM-DAQ* processor module or *ibaM-COM* communication module

Software

- *ibaPDA* version 8.10.0 or higher

Firmware

- ibaMAQS version 1.02.004 or higher

6 Mounting and dismantling

Danger!



Operation

- The system must only be operated permanently connected and not touchable, only in a building (in-door) and only in a fire protection housing in accordance with IEC 61010-1.
 - The system must only be operated with a mounted end cover.
 - The external power supply/power supply unit for supplying the central unit and thus for the complete system must be tested for use with this system in accordance with IEC 61010-1.
 - Modules from this system must only be operated with a central processing unit from this system.
 - The supply voltage for this system must only be fed from this system via a central unit.
 - The supply may only be provided via an energy-limited circuit in accordance with IEC 61010-1 and must either include a fuse that trips after 120 s at the latest in the event of an overcurrent greater than 4 A or limit the total current of the system to 4 A.
 - In addition to their own current consumption from the supply voltage via the module-module interface, the central units and the modules also pass on the supply voltage for other connected modules, so that the module-module interfaces may have to carry the maximum specified total current of the system.
 - Only a maximum of 15 modules may be installed next to the central unit.
-

The modular system is designed as follows and is to be mounted on the DIN rail:

- Central unit on the far left
- Up to 15 modules to the right of the central unit
- End cover on the far right to protect the contacts

Make sure that the modules

- are properly secured to the DIN rail and
- are correctly positioned in the side guide rails.

Check the correct fitting of the modules after mounting by a visual inspection.

Note

An end cover is included in the scope of delivery of the central unit.
The end cover is also available as an accessory or spare part from iba.

Installation clearances

Ensure a minimum clearance of the entire system of 30 mm upwards and downwards and 10 mm to the right and left for sufficient ventilation of the device.

6.1 Disconnection from the grid

To enable safe, hazard-free work on the system, all live components in the system must be disconnected from the grid.

Warning!**Mounting and dismounting / Disconnection from the grid**

Work on the device or system may only be carried out when the power is switched off!

Due to the modular concept of this system, modules connected in series with this module can also carry dangerous voltages.

All energized components of all modules in the system must therefore be disconnected from the grid before mounting and dismounting.

In addition to disconnecting the power supply at the system's central unit, the signal plugs and connections of all modules in the system must also be de-energized or disconnected from the grid.

Caution!

A suitable disconnecting device for this system must be available and disconnect all energized components of this system.

This disconnecting device must include a switch or circuit breaker that is easily accessible at a suitable location in the vicinity and is also clearly marked as a disconnecting device for this system.

6.2 Modules

Mounting

- Shut down the system and/or switch off the power supply.
- Disconnect the power supply and the entire system from the mains as instructed in chapter [↗ Disconnection from the grid, page 15](#).
- Remove the end cover, if present.
- Lift the green lever of the module upwards.
- Push the module backwards along the guide rails onto the DIN rail.
- Push down on the green lever.
- To protect the side contacts from dirt and damage, install the end cover on the last module.
- Switch on the power supply.
- Start the system.

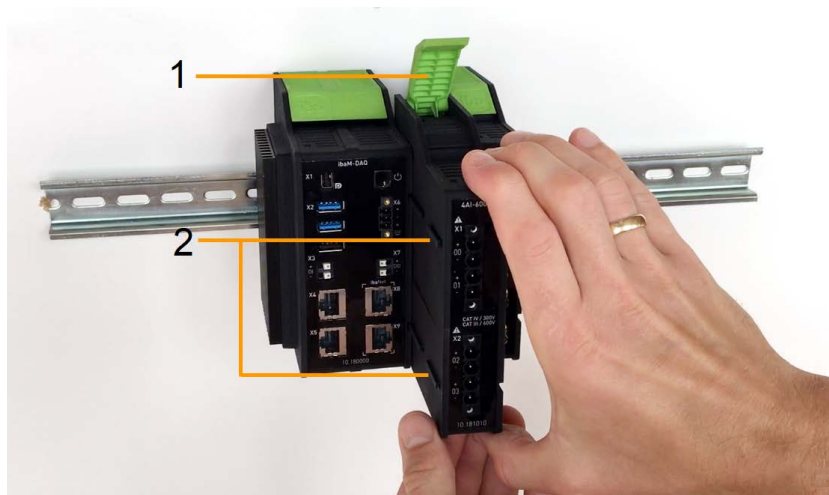

- 1 Green lever for locking and releasing the modules
- 2 Guide rails

Dismounting

- Shut down the system and/or switch off the power supply.
- Disconnect the power supply and the entire system from the mains as instructed in chapter [↗ Disconnection from the grid, page 15](#).
- Remove all connections from the module that is to be dismantled.
- If you want to dismantle the module on the far right, first remove the end cover. This is mounted again on the last module on the right after the module has been dismantled.

- Grasp the module at the top and bottom with one hand and lift the green lever upwards to release the lock on the DIN rail.
- Pull the module forward along the guide rails.
- Push down on the lever.

6.3 End cover

The rightmost module is terminated on the right side with the end cover ibaM-CoverPlate.

Mounting

- Push this end cover along the guide rail until the cover snaps into place.

Dismounting

- Push this end cover forward along the guide rail.

Note



An end cover is included in the scope of delivery of the central unit.
The end cover is also available as an accessory or spare part from iba.

6.4 Connection technology connector

Caution!



You must only connect one conductor to each terminal connection.

Several individual conductors, whether single-wired or fine-wired, are not permitted.

Only connectors classified by iba may be used for connecting conductors.

Connection technology	Push-in				
Clamping range	0.08 - 2.5 mm ²				
Conductor cross-section					
Single-wired	0.5 - 1.5 mm ²				
Fine-wired	0.5 - 2.5 mm ²				
With wire end ferrule	0.5 - 2.5 mm ²				
With wire end ferrule/collar	0.5 - 2.5 mm ²				
Stripping length					
Cross-section	0.5 mm ²	0.75 mm ²	1 mm ²	1.5 mm ²	2.5 mm ²
Single-wired	10 mm				
Fine-wired					
With wire end ferrule	10 mm				
With wire end ferrule/collar	12 mm			n/a	
Recommended cables					
Single-wired	H05V-U; H07V-U				
Fine-wired	H05V-K; H07V-K				
Screwdriver blade	0.6 mm x 3.5 mm				

Caution!



Measuring cable

- Do not use damaged measuring cables!
- Do not connect or disconnect measuring cables when the device is connected to the power!
- Measuring cables must be suitable for the measurement category and voltage, and must have a length of smaller than 10 m.

7 Device description

Here you will find views and descriptions of the *ibaM-4AI-600V-AC* device.

7.1 View

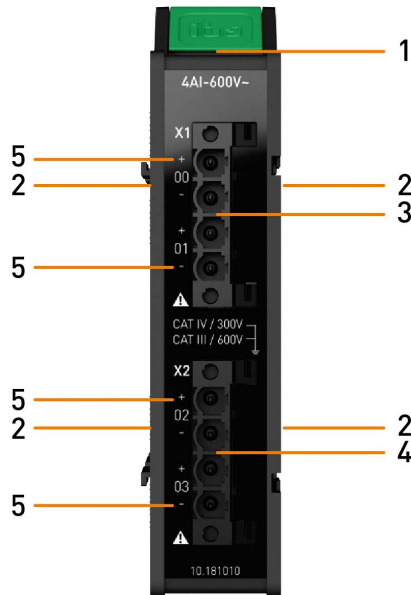

- 1 Module status indicator
- 2 Contacts module-module interface
- 3 Connector analog input X1
- 4 Connector analog input X2
- 5 Analog input indicators

7.2 Indicating elements

Colored LEDs on the device indicate the state of the device and of the analog inputs.

7.2.1 Module status

Color	Status	Description
--	off	down, no power supply
Green	on	ready for operation
	flashing slowly	device is booting
	flashing quickly	update is running
Red	on	error, reset

7.2.2 Analog input status

Color	Status	Description
--	off	channel inactive channel active and no input signal received, or input signal received but not measurable (<1% of nominal upper range value)
Green	on	channel active and measurable input signal received
Red	on	channel active and input signal outside measuring range or greater than the maximum permissible voltage based on the corresponding CAT protection class

7.3 Analog inputs

Here you will find information on filters and connections for the analog inputs.

7.3.1 Filters

The following filters are available for each channel:

Filter type	Order	Cut-off frequency	ADC signals	Filter signals
R/C low-pass	1st	150 kHz	x	x
Digital anti-aliasing filter (FIR)	84th	0.45 x ADC sampling rate Over sampling = 32 x ADC sampling rate	x	x
Digital anti-aliasing filter (Elliptic/Cauer)	10th	0.45 / timebase		x

ADC sampling rate = A/D converter sampling rate

Timebase = Configured timebase or update time in *ibaPDA*

ADC signals = Acquired signals after A/D converter

Filter signals = Acquired signals after additional digital filter (see also filter section)

Filter section:

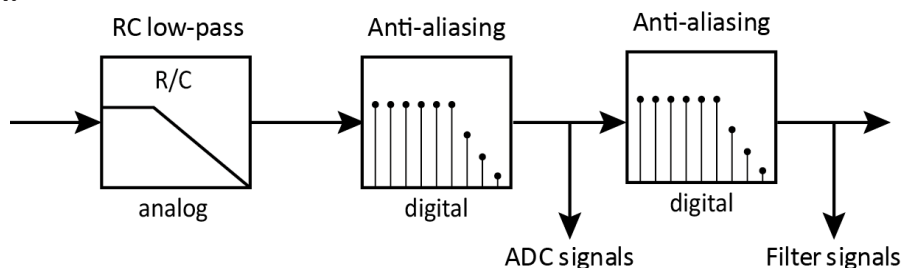

7.3.2 Power frequency measurement

One power frequency measurement is available per channel.

For information on parameterization, see [ibaM-4AI-600V-AC – Power frequency tab, page 29](#).

In addition to the actual measured values, the power frequency signals are available as virtual signals in the signal tree and can be displayed, recorded and used for calculations like all other signals.

Properties

- Frequency
Frequencies between 10 Hz and 80 Hz are supported.
- Measuring interval

Measuring interval	Standard conformity	Accuracy
1 s	-	± 5 mHz
10 s	according to DIN EN 61000-4-30	± 0.5 mHz

7.3.3 Connection diagram, pin assignment

A total of 4 input signals can be connected here (0 ... 3), each of which must be bipolar and electrically isolated. Each channel is connected using a two-wire system.

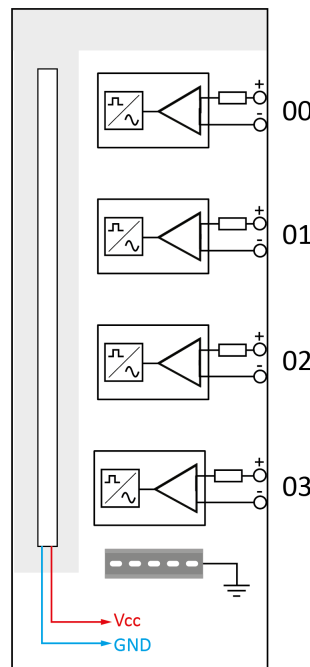

Pin assignment

Connector	Pin	Connection
X1	1	Analog input 00 +
	2	Analog input 00 -
	3	Analog input 01 +
	4	Analog input 01 -
X2	1	Analog input 02 +
	2	Analog input 02 -
	3	Analog input 03 +
	4	Analog input 03 -

Caution!



Measuring cable

- Do not use damaged measuring cables!
- Do not connect or disconnect measuring cables when the device is connected to the power!
- Measuring cables must be suitable for the measurement category and voltage, and must have a length of smaller than 10 m.

Circuit diagram

The input circuit diagram of one channel is shown here as an example.

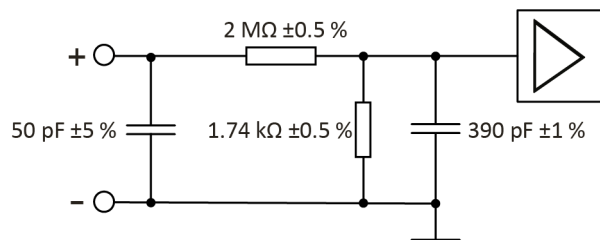

7.4 Type label

The type label provides the following information:

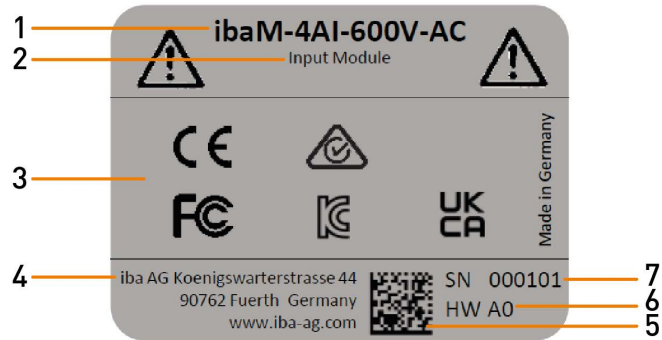

- | | | | |
|---|---------------------------|---|--------------------------------|
| 1 | Product name | 5 | DataMatrix code (iba internal) |
| 2 | Module type | 6 | Hardware version |
| 3 | Certifications, Standards | 7 | Serial number |
| 4 | Manufacturer | | |

8 Configuration in ibaPDA

With *ibaPDA* you can search for devices in the network and configure them for operation in the network, but *ibaPDA* can also be used to configure, acquire and record the analog and digital signals of the connected terminals, and output them.

Modules from the ibaMAQ system can only be operated at an ibaMAQS central unit, either at the processor module *ibaM-DAQ* or communication module *ibaM-COM*. Configure the respective central unit before adding further modules.

Other documentation



Please read the description and configuration of the modules *ibaM-DAQ* or *ibaM-COM* in the corresponding device manuals.

8.1 Adding modules

There are several ways to add modules in *ibaPDA*:

- Automatically
- Manually / offline

The procedure is described using the example of the communication module *ibaM-COM*.

8.1.1 Adding module automatically

1. Select the "ibaM-COM" link in the I/O Manager.
2. Right-click on the link to open a submenu.
3. Select *Autodetect*.

→ If *ibaPDA* detects the device automatically, the device and the connected modules are listed in the module tree.

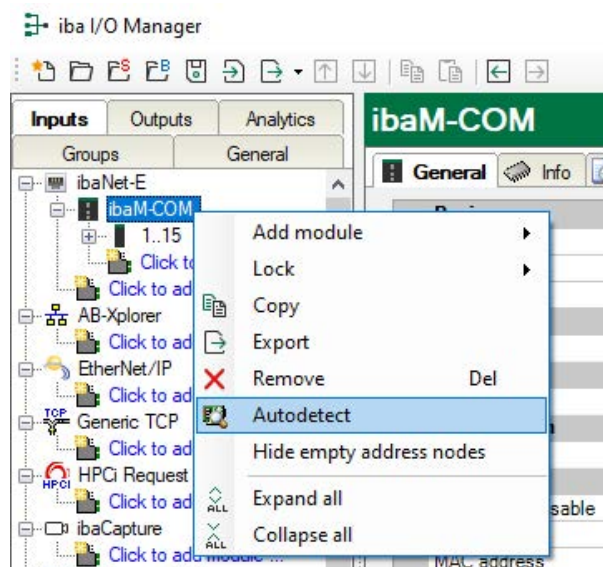

8.1.2 Adding module manually / offline

Modules can also be added manually.

1. Right-click on the "ibaM-COM" link and select *Add module*.
2. Select the desired modules from the list.

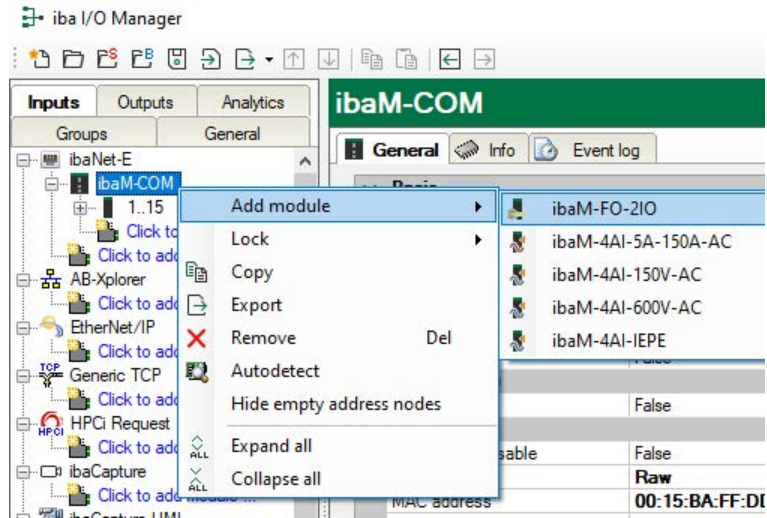

An offline configuration makes it possible, for example, to export a module configuration without existing or connected modules or to save the entire I/O configuration of the I/O Manager.

Other documentation



For detailed information, refer to the corresponding device manuals.

8.2 Module configuration

If the module is displayed correctly, carry out the configuration as described below.

8.2.1 ibaM-4AI-600V-AC – General tab

In the *General* tab, you can make basic settings for the module and select the measuring range for each channel.

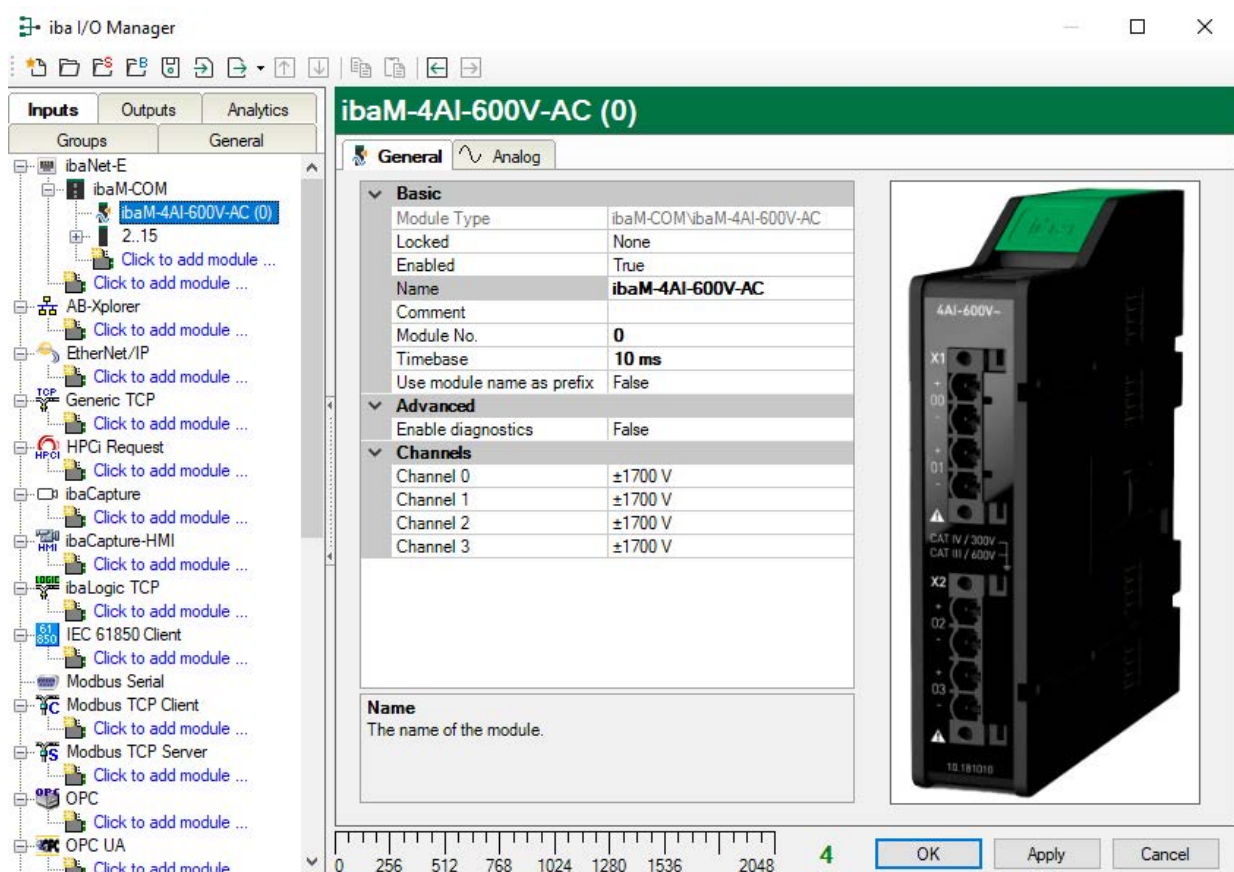

Basic

Module Type (information only)

Indicates the type of the current module.

Locked

You can lock a module to avoid unintentional or unauthorized changing of the module settings.

Enabled

Enable the module to record signals.

Name

You can enter a name for the module here.

Comment

You can enter a comment or description of the module here. This will be displayed as a tooltip in the signal tree.

Module No.

This internal reference number of the module determines the order of the modules in the signal tree of *ibaPDA* client and *ibaAnalyzer*.

Timebase

All signals of the module are sampled on this timebase.

Use module name as prefix

This option puts the module name in front of the signal names.

Advanced**Enable diagnostics**

If you enable diagnostics (True), the *Diagnostics* tab is added. See ↗ *ibaM-4AI-600V-AC – Diagnostics tab*, page 30.

Channels**Channel x**

Enable the channel by selecting the measuring range or disable the channel in the drop-down menu.

- Off: Channel is disabled
- ±360 V
- ±1700 V (default)

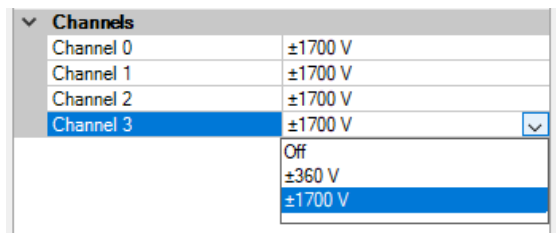

8.2.2 ibaM-4AI-600V-AC – Analog tab

The *Analog* tab lists the analog signals in two groups. The *ADC* group contains the ADC signals directly after the A/D converter, while the *Filtered* group contains the filter signals with the additional digital anti-aliasing filter.

ibaM-4AI-600V-AC (0)							
General		Analog					
Name	Unit	Input range	Min	Max	Active	Actual	
ADC							
0	ADC signal Ch 0	V	±1700 V	-1700	1700	<input checked="" type="checkbox"/>	0
1	ADC signal Ch 1	V	±1700 V	-1700	1700	<input checked="" type="checkbox"/>	0
2	ADC signal Ch 2	V	±1700 V	-1700	1700	<input checked="" type="checkbox"/>	0
3	ADC signal Ch 3	V	±1700 V	-1700	1700	<input checked="" type="checkbox"/>	0
Filtered							
4	Filtered signal Ch 0	V	±1700 V	-1700	1700	<input type="checkbox"/>	0
5	Filtered signal Ch 1	V	±1700 V	-1700	1700	<input type="checkbox"/>	0
6	Filtered signal Ch 2	V	±1700 V	-1700	1700	<input type="checkbox"/>	0
7	Filtered signal Ch 3	V	±1700 V	-1700	1700	<input type="checkbox"/>	0

Name

You can enter a signal name here, as well as two comments, by clicking on the  icon in the *Name* field.

Unit

The unit “V” is preset.

Input range

Displays the input range, based on the setting on the *General* tab.

Min/Max

You can define an upper and lower limit for the measuring range here. The analog voltage level of the upper and lower limit is assigned to a physical variable. The dialog box is opened by clicking on the cross.

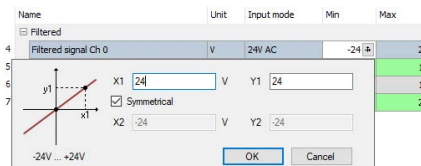

Active

You can enable or disable the signal here.

Actual

Displays the current measured value.

You can show or hide additional columns using the context menu (right-click in the header).

8.2.3 ibaM-4AI-600V-AC – Power frequency tab

If frequency measurement is enabled, this tab is also displayed.

ibaM-4AI-600V-AC (1)					
General Analog Power frequency [10Hz..80Hz]					
	Name	Unit	Interval	Active	Actual
20	Power frequency Ch 0	Hz	10s (DIN EN 61000-4-30)	<input type="checkbox"/>	0 Hz
21	Power frequency Ch 1	Hz	10s (DIN EN 61000-4-30)	<input type="checkbox"/>	0 Hz
22	Power frequency Ch 2	Hz	10s (DIN EN 61000-4-30)	<input type="checkbox"/>	0 Hz
23	Power frequency Ch 3	Hz	10s (DIN EN 61000-4-30)	<input type="checkbox"/>	0 Hz

Name

The signal name is preset. You can enter two comments by clicking on the  icon in the *Name* field.

Unit

The unit "Hz" is preset.

Interval

You can select the measurement interval from a dropdown list: 1s or 10 s (according to DIN EN 61000-4-30).

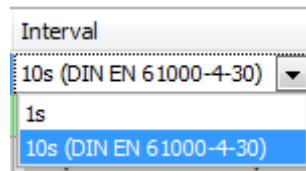

Active

You can enable or disable the signal here.

Actual

Displays the current signal value.

You can show or hide additional columns, if available, using the context menu (right-click in the header).

8.2.4 ibaM-4AI-600V-AC – Diagnostics tab

The *Diagnostics* tab displays the analog and digital diagnostic signals. The signals can be enabled individually.

Digital values:

ibaM-4AI-600V-AC (0)			
General Analog Diagnostics			
Analog values Digital values			
Name	Active	Actual	
Diagnostic			
100 Hardware state	<input type="checkbox"/>	0	
101 Error Ch 0	<input type="checkbox"/>	0	
102 Error Ch 1	<input type="checkbox"/>	0	
103 Error Ch 2	<input type="checkbox"/>	0	
104 Error Ch 3	<input type="checkbox"/>	0	

Analog values:

ibaM-4AI-600V-AC (0)			
General Analog Diagnostics			
Analog values Digital values			
Name	Unit	Active	Actual
Diagnostic			
100 Calibration date	s	<input type="checkbox"/>	0 s

Meaning of the signals:

Name	Description
Hardware state	live bit to indicate the hardware status (1 Hz)
Error Ch x	hardware error in channel x
Calibration date	32-bit value that represents the seconds since 1970. This number can be converted to text using a virtual signal: <i>ConvertUnixTimeToText()</i>

9 Technical data

Danger!



Electric shock

The device is only designed for electrical measured variables as specified in the “Technical data” chapter!

If the device is used or operated in a manner other than specified in the *Technical data* chapter, the protection supported by the device may be impaired.

This applies in particular to the permissible operating and environmental conditions and voltages outside the corresponding CAT protection classes.

9.1 Main data

Short description

Product name	ibaM-4AI-600V-AC
Module label	4AI-600V~
Description	input module with 4 analog voltage inputs with modes switchable by channel
Order number	10.181010

Module-module interface

Number	2
Connection technology	4x 8 sliding contacts

Supply

Supply voltage	24 V DC via module-module interface
Current consumption (max.)	
Own consumption	0.16 A
Input/output current	4 A

Other interfaces, operating and indicating elements

Indicators	LEDs for operation, channel states and errors
------------	---

Operating and environmental conditions

Temperature range	
Operation	14 °F to 131 °F (-10 °C to +55 °C)
Storage	-13 °F to 185 °F (-25 °C to +85 °C)
Mounting	on grounded DIN rail according to EN 50022 (TS 35, DIN Rail 35)

Cooling	passive
Relative humidity	15 % ... 95 % (indoor), no condensation
Operating altitude	0 ... 2000 m above sealevel
Protection type	according to IP20; without test certificate according to IEC 60529
Certifications / standards	CE, C-Tick, UKCA, FCC, IEC 61010-1, IEC 61010-2-030, IEC 61000-6-5 interface range 4
Pollution degree	2
MTBF ¹⁾	3,452,457 hours / 394 years
Dimensions	
w x h x d	28 mm x 133 mm x 120 mm
Height, lever open	160 mm
Height units	3
Installation clearances	
Top / bottom	30 mm / 30 mm
left/ right (system)	10 mm / 10 mm
Installation position	vertical, lever up
Weight / incl. packaging	0.26 kg / 0.52 kg

9.2 Analog inputs

Analog inputs

Number	4
Design	galvanically isolated, single ended
Input signal / nominal voltage	600 V AC
Resolution	24 bit (Delta-Sigma)
ADC sampling rate	500 kHz
Timebase ibaPDA (update time)	min. 2 μ s; freely adjustable (integer multiple); max. 1 ms for filter signals
Filters	
ADC signal	
analog	R/C low pass, 1st order, typ. 150 kHz
digital	anti-aliasing filter (FIR), 84th order; cutoff frequency = 0.45 x sampling rate ADC; oversampling = 32 x sampling rate ADC
Filter signal ²⁾	

¹⁾ according to: Telcordia 4 SR332 (Reliability Prediction Procedure of Electronic Equipment; Issue Mar. 2016) and NPRD (Non-electronic Parts Reliability Data 2011)

²⁾ For the filter signals, the maximum time base in ibaPDA (update time) is limited to 1 ms for the correct operation of these filters.

like ADC signal, in addition:	
digital	anti-aliasing filter (Elliptic/Cauer) 10th order; cutoff frequency 0.45/timebase
Measuring ranges	$\pm 360 \text{ V}$ / $\pm 1700 \text{ V}$; switchable by channel
Measuring category	CAT III 600 V / CAT IV 300 V
Input impedance	
Device switched on	2.0 M Ω
Device switched off	2.0 M Ω
Input capacity	50 pF
Accuracy (+25 °C) ³⁾	< 0,1 % of the respective double full scale value
Electrical isolation	
Channel-channel	basic insulation: CAT III 600 V
Channel-system	reinforced insulation: CAT III 600 V
Connection technology	2x 4-pin pin header, pitch 7.62 mm
Connector	2x enclosed; push-in, conductor max. 2.5 mm ² , locking lever (latching), reverse polarity protection, lockable; information on conductor and stripping length, see chapter ↗ <i>Connection technology connector</i> , page 18; order no. 52.000050

Additional functions

Phasor Measurement Unit ⁴⁾	integrated
Power frequency (10 Hz ... 80 Hz)	intervall 1 s / 10 s (according to IEC 61000-4-30)

³⁾ If the device is used or operated in the manner specified in the Technical data chapter, a calibration interval of 4 years is recommended for the analog input channels.

⁴⁾ only available on release of ibaM-PQU

9.3 Declaration of conformity

Supplier's Declaration of Conformity
47 CFR § 2.1077 Compliance Information

Unique Identifier:
 10.181010 ibaM-600V-AC

Responsible Party - U.S. Contact Information
 iba America, LLC
 370 Winkler Drive, Suite C
 Alpharetta, Georgia
 30004

(770) 886-2318-102
www.iba-america.com

FCC Compliance Statement
 This device complies with Part 15 of the FCC Rules. Operation is subject to the following two conditions: (1) This device may not cause harmful interference, and (2) this device must accept any interference received, including interference that may cause undesired operation.

9.4 Dimensions

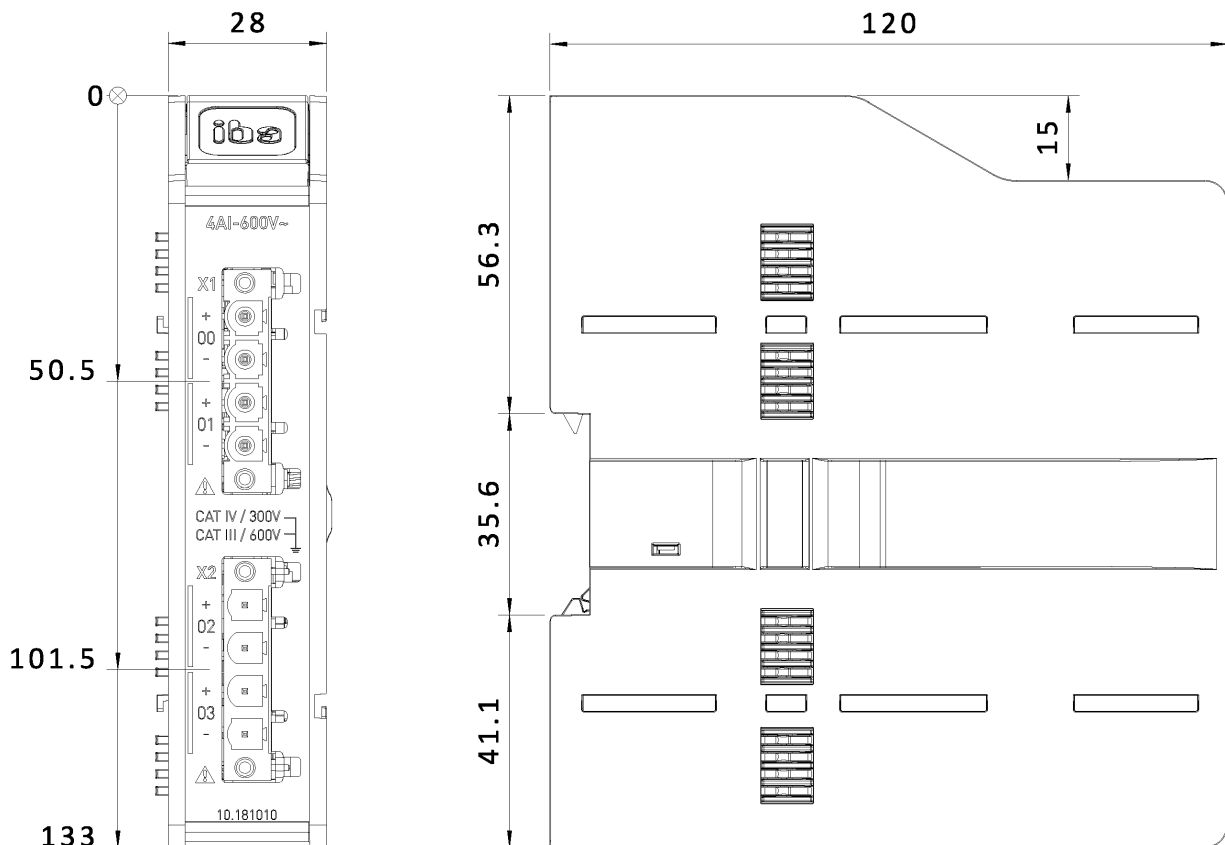

Dimensions *ibaM-4AI-600V-AC*, dimensions in mm

10 Accessories

Connector for analog inputs

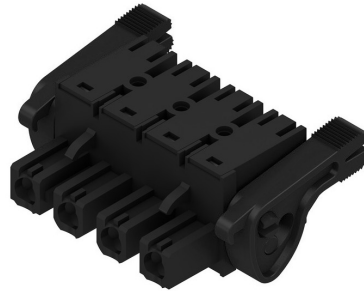

Short description	
Name	4-Pin Terminal Block MAQS-PM RM7.62 Push-In LR
Description	4-pin socket connector/connector for analog inputs, push-in, lockable
Order number	52.000050

End cover for MAQS modules

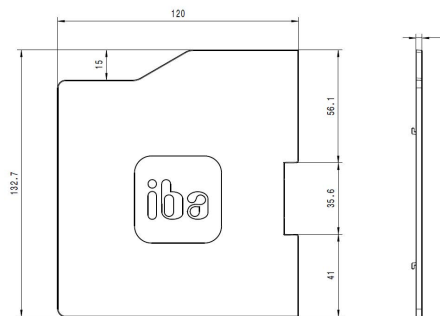

Short description	
Name	ibaM-CoverPlate
Description	End cover for MAQS modules
Order number	10.180020
Design	
Dimensions (w x h x d)	3 mm x 132.7 mm x 120 mm
Weight	0.05 kg

11 Support and contact

Support

Phone: +49 911 97282-14

Email: support@iba-ag.com

Note



If you need support for software products, please state the number of the license container. For hardware products, please have the serial number of the device ready.

Contact

Headquarters

iba AG
Gebhardtstrasse 10-20
90762 Fuerth
Germany

Phone: +49 911 97282-0

Email: iba@iba-ag.com

Mailing address

iba AG
Postbox 1828
D-90708 Fuerth, Germany

Delivery address

iba AG
Gebhardtstrasse 10
90762 Fuerth, Germany

Regional and worldwide

For contact data of your regional iba office or representative please refer to our web site:

www.iba-ag.com